

REVISION			
REV.	DESCRIPTION	DATE	APPROVED
A	Changed P1 Pin Out	03-12-07	DP

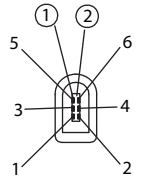

FRONT

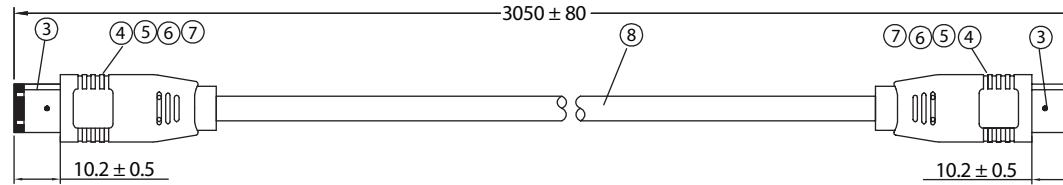

IEEE 1394 6P/M MOLDING TYPE
(TOOLING NO:G102-216)

IEEE 1394 6P/M MOLDING TYPE
(TOOLING NO:G102-216)

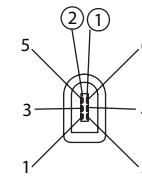

P2

FRONT

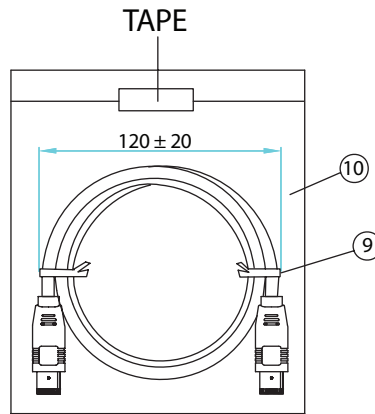

PIN OUT

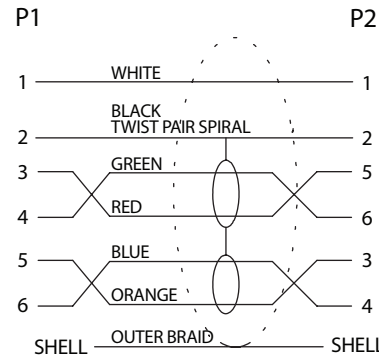

NOTES:

- CABLE: UL20276 IEEE1394
[(30AWGx1P+FOIL+SP)x2+24AWGx2C+MYLAR+FOIL+BD]x1
OUTER PVC JACKET: BLACK, OD: 5.7 ± 0.2mm
PRINTING: "E166307  AWM 20276 30AWG VW-1 IEEE Std 1394 Compliant"
- CONNECTORS: IEEE 1394 6P MALE TO IEEE 1394 6P MALE
- HOOD: MOLDED TYPE, COLOR: BLACK
- ELECTRICAL TEST:
<1>.100% OPEN SHORT & MISS WIRE TEST
<2>.INSULATION RESISTANCE: DC400V 10M ohm MIN.
<3>.CONDUCTOR RESISTANCE: 3 ohm MAX.
- PACKING: 1PC/POLYBAG

No.	PARTS NAME	SPECIFICATION STANDARD	QTY	REMARKS
①	6P/M - CONTACT	PHOSPHOR BRONZE / GOLD FLASH	12	
②	6P/M - INSULATOR	PBT / BLACK UL94V-0	2	
③	6P/M - SHELL 1	IRON / NICKEL PLATED	2	
④	6P/M - SHELL 2	IRON / NICKEL PLATED	2	
⑤	COPPER FOIL	5x10mm	2	
⑥	6P/M - INNER MOLD	PE / NATURAL	2	
⑦	6P/M - OUTER MOLD	45P PVC / COLOR: BLACK	2	
⑧	KL02001ABK01A	[(30AWGx1P+FOIL+SP)x2+24AWGx2C+MYLAR+FOIL+BD]x1 COLOR: BLACK	1	
⑨	MINI TIE	PE / BLACK	2	
⑩	POLYBAG	PE / 0.08x160x180mm	1	

Dim range (mm)	Tolerance +/- (mm)	Qualtek Electronics Corp. WCT DIVISION		
		Part Number: 1821013-10		
0-1	0.15	Description: IEEE 1394 6P/M - IEEE 6P/M		
1-6	0.20			
6-18	0.30	REV. A		
18-50	0.50			
50-120	0.70	Drawn / Date	Checked / Date	Approved / Date
120-250	0.90	B.Grubb 01-25-07	01-25-07	JJH / 01-25-07
250-500	1.20			